

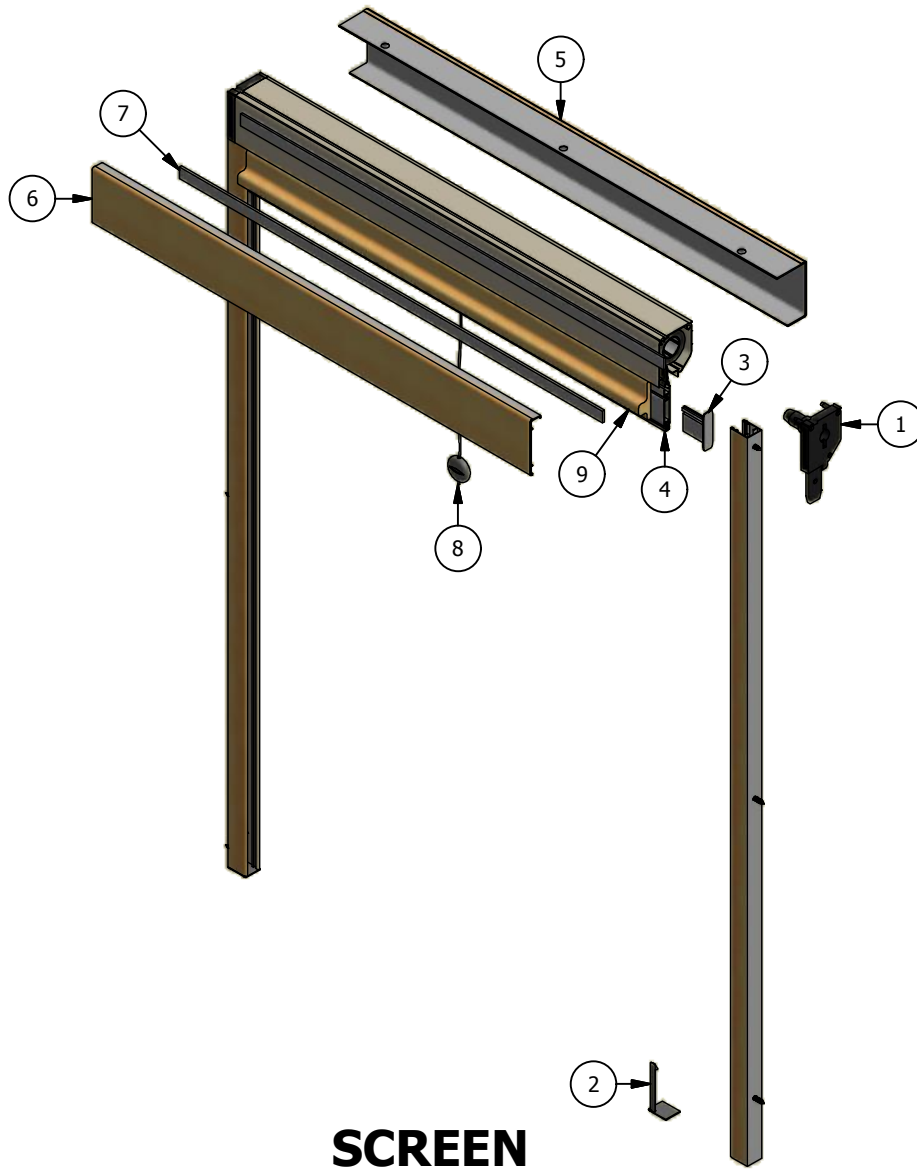

**WINDSOR**  
WINDOWS & DOORS  
A Woodgrain Millwork Company

# Pinnacle Select Series Retractable Screen

## Parts Identification









**SCREEN**  
INTERIOR VIEW



**WINDSOR**  
WINDOWS & DOORS  
A Woodgrain Millwork Company

# Pinnacle Select Series Retractable Screen

## Parts Identification



Image	Item #	Description	Color / Finish / Size	Spec	Part #
		Retractable Screen Assembly (Screws Included)			
	1	Cassette End Cap (RH Shown)		RH LH	659893 659894
	2	End Cap/Latch for Guide (RH Shown)		RH LH	659891 659892
	3	Pull Bar End Cap (RH Shown)		RH LH	659895 659896
	4	Pile Weatherstrip		LF	659897
No Image		Screw Pack & Warning Label #6 x 3/4" (Qty.8)			659898
	5	Outside Screen Cover  Outside Screen Cover Screws #8 x 3/4" Screw			8' Mill Veneer 2391363 14' Pine Veneer 2391364 14' Fir Veneer 2391365 14' Alder Veneer 2391366  508152
	6	Inside Screen Cover			8' Mill Veneer 2391359 14' Pine Veneer 2391360 14' Fir Veneer 2391361 14' Alder Veneer 2391362
No Image	7	Inside Screen Cover Tape 1/8" x 1/2" Double Sided	White - 108' Roll		394101



**WINDSOR**  
WINDOWS & DOORS  
A Woodgrain Millwork Company

# Pinnacle Select Series Retractable Screen

## Parts Identification

Image	Item #	Description	Color / Finish / Size	Spec	Part #
	8	Screen Pull Cord (Optional)			671100
	9	Wood Pull	8' Pine Lineal 8' Alder Lineal 8' Fir Lineal		590173 590173-A 590173-F