

Pinnacle Series

ACCESSORIES

ALUMINUM EXPANDERS AND MULLIONS

THESE ALUMINUM ACCESSORIES CAN BE APPLIED TO WINDSOR CLAD CASEMENT, AWNING, DOUBLE HUNG, GLIDE-BY, SLIDING PATIO DOOR AND DIRECT SET WINDOWS.

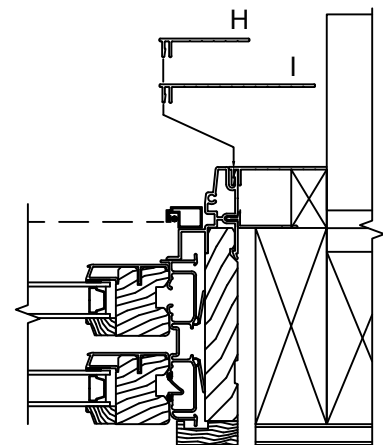
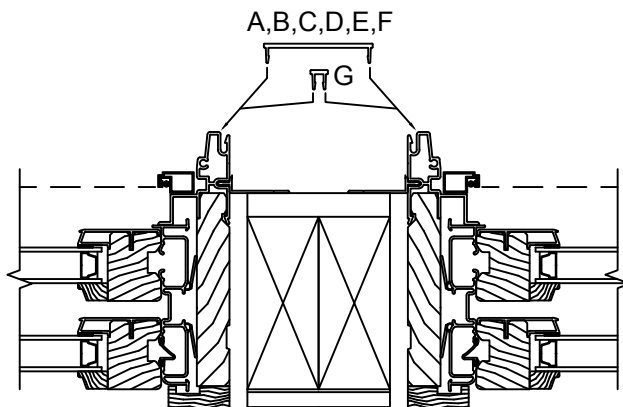
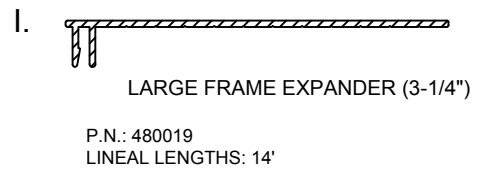
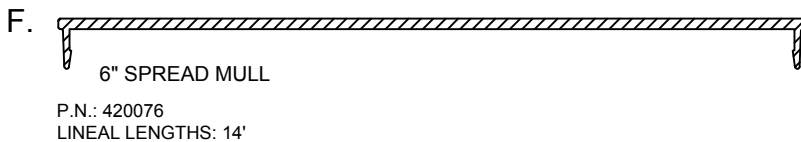
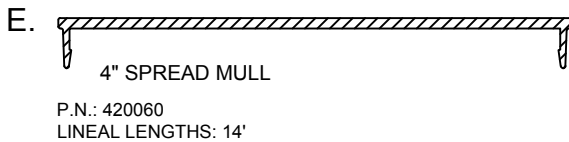
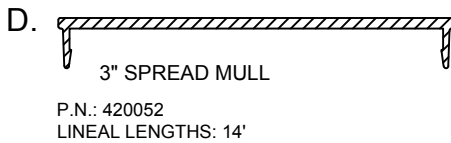
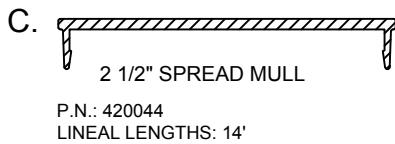
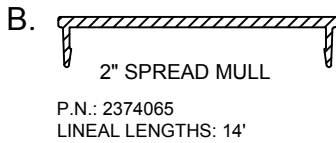
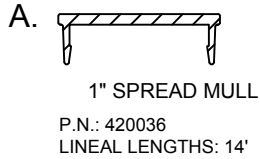

Pinnacle Series

ACCESSORIES

LINEAL PARTS



P.N. 2390000
LINEAL - 16'

3 1/2" FLAT CASING



P.N. 2380448
LINEAL - 14'

4 1/2" BACKBAND CASING

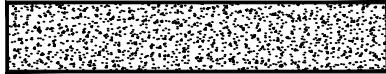

P.N. 2390001
LINEAL - 16'

5 1/2" FLAT CASING



P.N. 2380065
LINEAL - 14'

WILLIAMSBURG BRICKMOULD



P.N. 2390003
LINEAL - 14'

BRICKMOULD WM-180

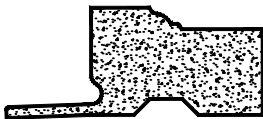

P.N. 2380059
LINEAL - 12'

180 FLANGED BRICKMOULD



P.N. 2380438
LINEAL - 14'

PRIMED CASEMENT SUBSILL

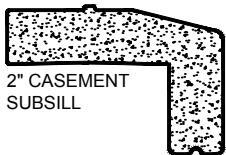

P.N. 2380022
LINEAL - 14'

2" CASEMENT SUBSILL



WOOD



PVC



P.N. 291018
LINEAL - 10'

CASEMENT 7/16 INCH JAMB EXTENSION



P.N. 291065
LINEAL - 10'

CASEMENT 7/16 INCH FULL WIDTH JAMB EXTENSION



P.N. 140122
LINEAL - 10'

CASEMENT 11/16 INCH EXTENSION JAMB



P.N. 291020
LINEAL - 10'

CASEMENT 1 1/8 INCH JAMB EXTENSION



P.N. 140103
LINEAL - 11'

DOUBLE HUNG / GLIDE BY 2 INCH JAMB EXTENSION



P.N. 291022
LINEAL - 8-16'

CASEMENT 2 7/16 INCH JAMB EXTENSION



P.N. 140123
LINEAL - 11'

CASEMENT 2 11/16 INCH JAMB EXTENSION



P.N. 291024
LINEAL - 10'

CASEMENT 3 1/8 INCH JAMB EXTENSION



P.N. 2381698
LINEAL - 14'

2" BULL SILL NOSE



P.N. 2379998
LINEAL - 12'

BELLY SILL NOSE



P.N. 2390019
LINEAL - 14'

DOUBLE HUNG SILL NOSE



P.N. 2390012
LINEAL - 14'

HORIZONTAL OUTSIDE MULL COVER



P.N. 2390013
LINEAL - 16'

VERTICAL OUTSIDE MULL COVER



P.N. 2390010
LINEAL - 12'

DOUBLE HUNG VERTICAL OUTSIDE MULL COVER

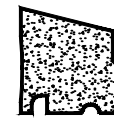

P.N. 2380021
LINEAL - 12'

HALF ROUND / ELLIPSE SILL NOSE

Pinnacle Series

ACCESSORIES

LINEAL WOOD PARTS

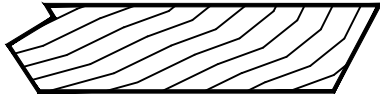

P.N. 292012

DOUBLE HUNG 30° BAY 6 9/16" JAMB EXTENSION

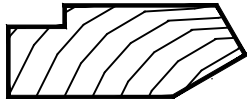

P.N. 292010

DOUBLE HUNG 30° BAY 4 9/16" JAMB EXTENSION

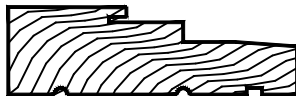

P.N. 291032

PRIMED CASEMENT / DIRECT SET JAMB

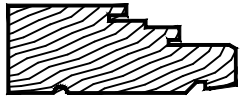

P.N. 2370043
LINEAL - 14'

CLAD CASEMENT / DIRECT SET JAMB



P.N. 291000
LINEAL - 10'

CASEMENT INSIDE MULL COVER

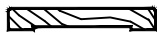

P.N. 292130
LINEAL - 11'

DOUBLE HUNG INSIDE MULL COVER



P.N. 291010
LINEAL - 10'

CASEMENT 45° BAY INSIDE MULL



P.N. 291008
LINEAL - 10'

CASEMENT 30° BAY INSIDE MULL



P.N. 291006
LINEAL - 10'

CASEMENT 12° INSIDE MULL

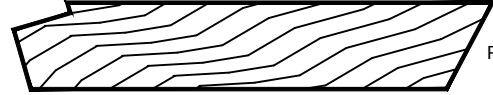

P.N. 292016

DOUBLE HUNG 45° BAY 6 9/16" JAMB EXTENSION



P.N. 292014

DOUBLE HUNG 45° BAY 4 9/16" JAMB EXTENSION



P.N. 250123
LINEAL - 10'

PRIMED & CLAD INSIDE STOP



P.N. 290080
LINEAL - 10'

DIRECT SET INSIDE STOP



P.N. 291040
LINEAL - 14'

PRIMED DIRECT SET OUTSIDE STOP

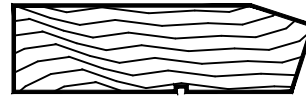

P.N. 291042
LINEAL - 7'

CASEMENT 30° BAY SIDE JAMB EXTENSION



P.N. 291030
LINEAL - 7'

CASEMENT 45° BAY SIDE JAMB EXTENSION



P.N. 291026
LINEAL - 7'

CASEMENT 4 WIDE BOW EXTENSION



P.N. 291028
LINEAL - 7'

CASEMENT 5 WIDE BOW EXTENSION



P.N. 237073
LINEAL - 11'

PRIMED & CLAD DOUBLE HUNG SILL INSIDE STOP

Pinnacle Series

ACCESSORIES

LINEAL METAL & VINYL PARTS

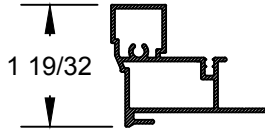

CLAD BRICKMOULD EXTRUSION

6063-T5 P.N.: 481025 LENGTH 17'
6063-T1 P.N.: 482166 LENGTH 17'

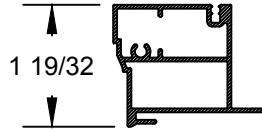

CLAD SQUARE BRICKMOULD EXTRUSION

6063-T5 P.N.: 481045 LENGTH 17'
6063-T1 P.N.: 481046 LENGTH 20'

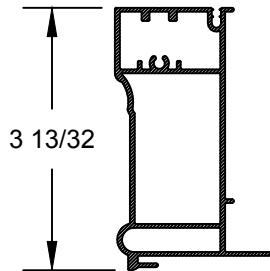

WILLIAMSBURG CASING

6063-T5 P.N.: 460033
6063-T52 P.N.: 460004
LINEAL LENGTHS: 17'

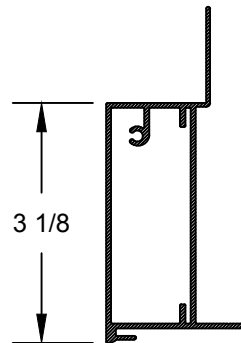

3 1/2" CLAD FLAT CASING

P.N. 460040
LINEAL LENGTH - 17'
MILL FINISH

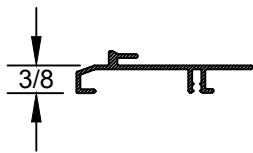

3/8" CLAD BRICKMOULD
SUBSILL EXTRUSION

P.N.: 482170
LINEAL LENGTHS: 14'

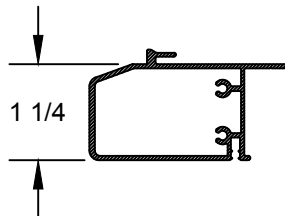

1 1/4" CLAD SUBSILL EXTRUSION

P.N. 460042
LINEAL LENGTH - 14'
MILL FINISH

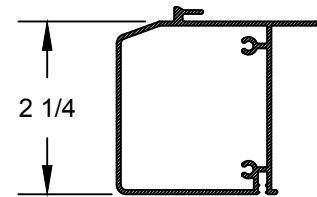

2 1/4" CLAD SUBSILL EXTRUSION

P.N. 460043
LINEAL LENGTH - 14'
MILL FINISH

Pinnacle Series

ACCESSORIES

LINEAL METAL & VINYL PARTS

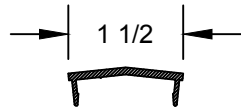

CLAD 12° OUTSIDE MULL
P.N.: 481001
LINEAL LENGTHS: 14'



CLAD BRICKMOULD FILLER STRIP
P.N.: 538031
LINEAL LENGTH: 12'

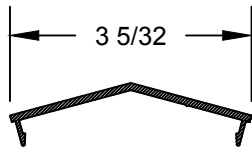

30° OUTSIDE MULL
P.N.: 480021
LINEAL LENGTHS: 14'

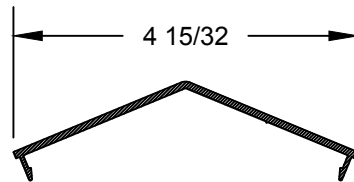

45° OUTSIDE MULL
P.N.: 481018
LINEAL LENGTHS: 14'

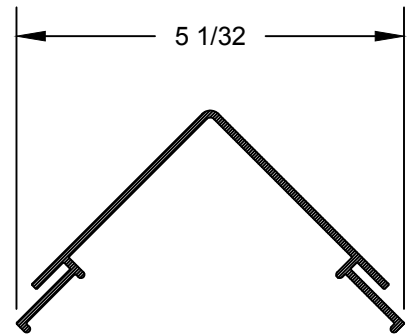

90° OUTSIDE MULL
P.N.: 584023
LINEAL LENGTHS: 14'



NAIL FIN (HINGED)
P.N.: 460015 LINEAL
LENGTH: 14'



NAIL FIN (NON HINGED)
P.N.: 478002 LINEAL
LENGTH: 14'



RIGID ALUMINUM NAIL FIN
P.N.: 460025 LINEAL
LENGTH: 14'

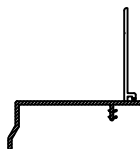

VINYL DRIP CAP (HINGED)
P.N.: 471005 LINEAL
LENGTH: 14'

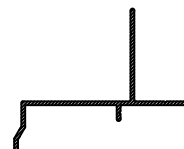

RIGID DRIP CAP
P.N.: 483046
LENGTH: 16'

Pinnacle Series

ACCESSORIES

INTERIOR TRIM PARTS

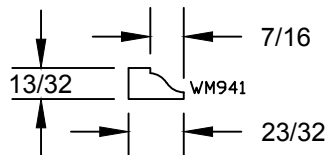
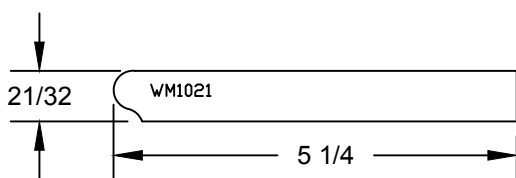
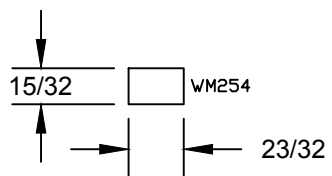
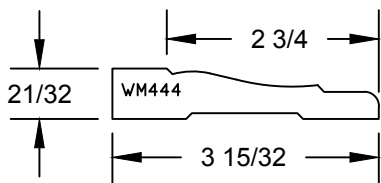
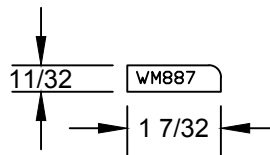
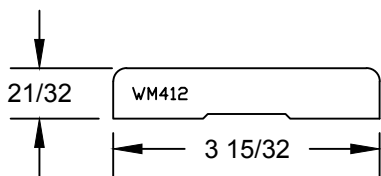
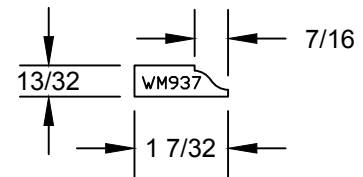
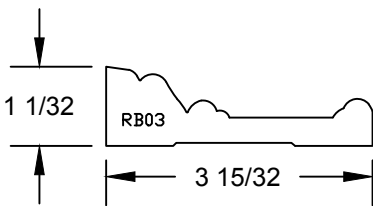
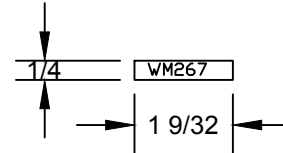
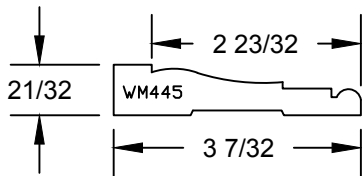
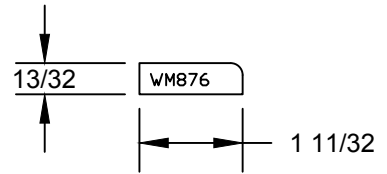
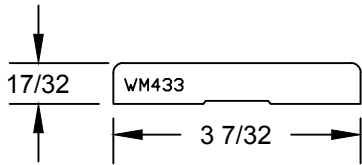

Pinnacle Series

ACCESSORIES

INTERIOR TRIM PARTS

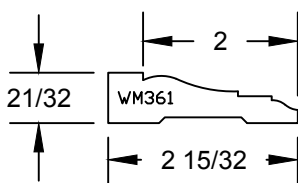
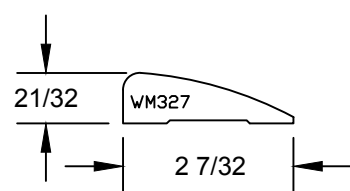
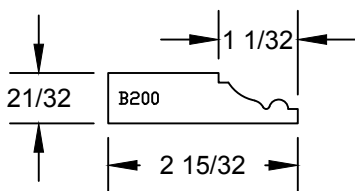
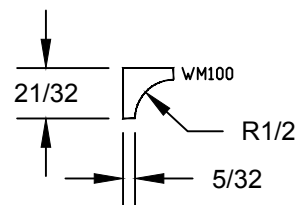
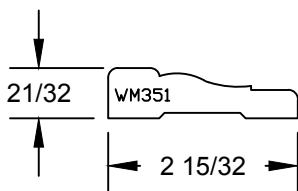
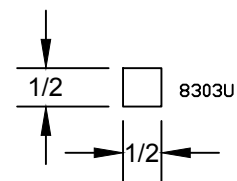
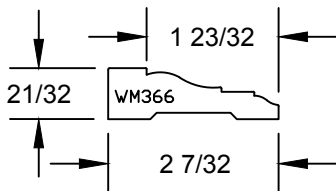
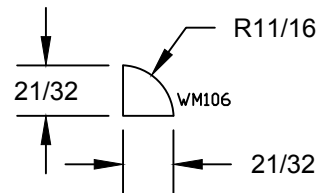
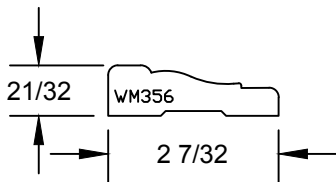
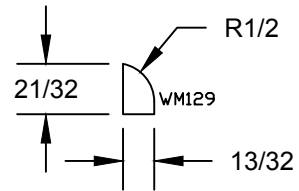
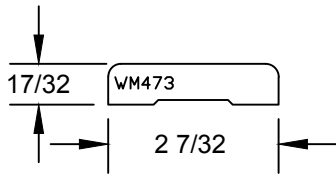

Pinnacle Series

ACCESSORIES

INTERIOR TRIM PARTS

