

# Next Dimension Signature Series

## Double Hung (Operating)

### Parts Identification

#### TOP SASH INTERIOR VIEW

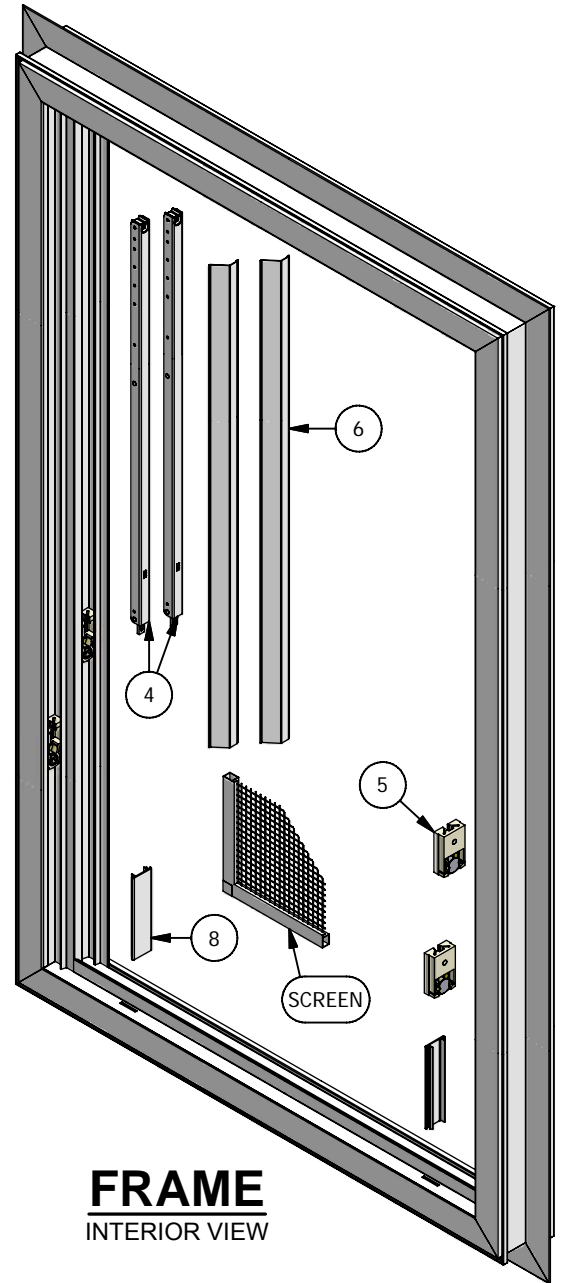
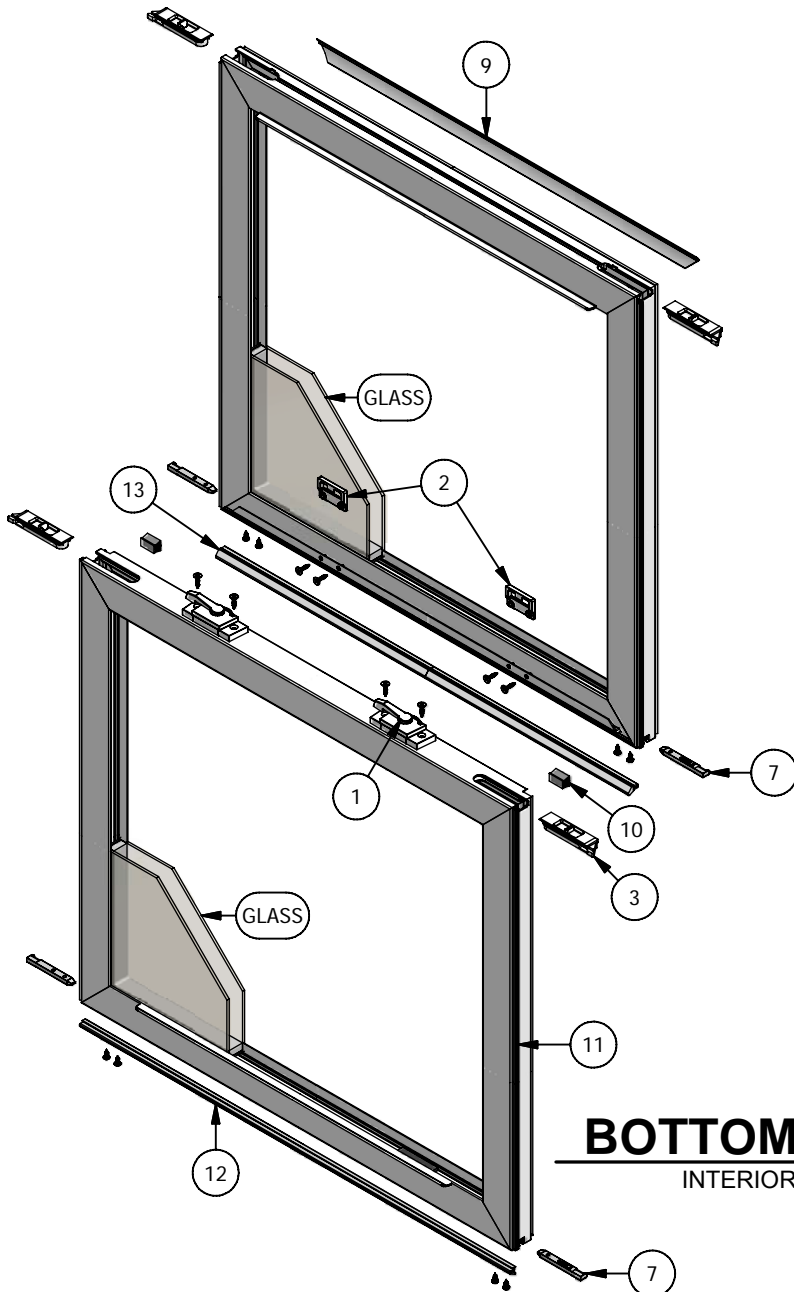

#### FRAME INTERIOR VIEW

#### BOTTOM SASH INTERIOR VIEW



# Next Dimension Signature Series

## Double Hung (Operating)

### Parts Identification

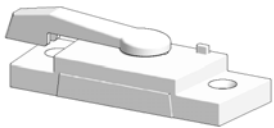
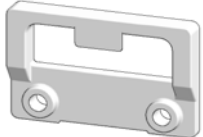
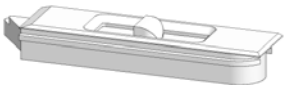

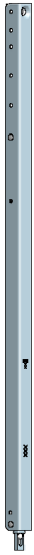
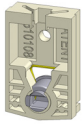

Image	Item #	Description	Color / Finish	Spec	Part #
	1	Lock	White Almond Clay		558170 558160 558172
		Lock Screws #6 x 7/8 Screw (Qty 2)	White Almond Clay		508181 508182 538182
	2	Keeper	White Almond Clay		558230 558231 545231
		Keeper Screws #6 x 5/8 Screw (Qty 2)	White Almond Clay		508085 508080 538080
	3	Tilt Latch	White	LH	558234
			White	RH	558235
			Almond	LH	558236
			Almond	RH	558237
			Clay	LH	558316
			Clay	RH	558315
	4	Balance	10A		421440
			12A		421455
			12B		421460
			14A		421470
			14B		421475
			14C		421480
			16A		421485
			16B		421490
			16C		421495
			18A		421500
			18B		421505
			18C		421510
			20A		421515
			20B		421520
			20C		421525
			20D		421530
22A		421535			
22B		421540			
22C		421545			
<i>Continued on Next Page</i>					



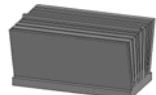



Image	Item #	Description	Color / Finish	Spec	Part #
	4	Balance	<i>Continued from Previous Page</i> 24A 421550 24B 421555 24C 421560 24D 421565 26A 421570 26B 421575 26C 421580 26D 421585 28A 421590 28B 421595 28C 421600 28D 421605 30A 421609 30B 421610 30C 421615 30D 421620 32A 421625 32B 421630 32C 421635 32D 421640 34A 421645 34B 421650 34C 421655 34D 421660 36B 421670		
	5	Balance Shoe	421690		
	6	Pocket Cover (Top)	White Almond Clay	13' 13' 13'	900735 900835 901835
	7	Tilt Pin  Tilt Pin Screws #6 x 5/8" Screw (Qty 1) #6 x 5/8" Screw (Qty 1) #6 x 3/8" Screw (Qty 1)	421695  White Flat Head Screw 508085 Clay Flat Head Screw 538080 Zinc Pan Head Screw 508183		



# Next Dimension Signature Series

## Double Hung (Operating)

### Parts Identification

Image	Item #	Description	Color / Finish	Spec	Part #
	8	Pocket Cover (Bottom)	White Almond Clay	13' 13' 13'	900740 900840 901840
	9	Glazing Bead	White Almond Clay Bronze Black Tan Ivory Cinnamon Green White	13'	900043 900110 901043 900043-BZ 900043-BK 900043-T 900043-I 900043-C 900043-G 900043-W
	10	Dust Pad	Grey		5800000
	11	Weatherstrip (Tri-Fin)	White Clay Black	LF LF LF	478067 478073 531102
	12	Weatherstrip (V-Fold) (Bottom Rail Only)	White Beige	LF LF	531098 531099
	13	Weatherstrip (Keeper Rail Only)	White Almond Clay Black	LF LF LF LF	531090 531091 531096 531103
 Not Shown on Assembly Dwg		Egress Sash Lift	White Almond Clay		558232 558233 545233
No Image		Glazing Tape 1/16" x 1/2"	White	216' Roll	394100



**WINDSOR**  
WINDOWS & DOORS  
A Woodgrain Millwork Company

# Next Dimension Signature Series

## Double Hung (Operating)

### Parts Identification

Image	Item #	Description	Color / Finish	Spec	Part #
 <p>Not Shown on Assembly Dwg</p>		Window Opening Control Device (Includes screws & Instructions) Field Applied Only	White Clay		941008 941009