

INSTALLATION GUIDELINES

for Legend HBR Doors

Installer

- Read instructions completely before attempting installation. Failure to follow these guidelines will forfeit all the Windsor warranty coverage, written or implied. Windsor Windows & Doors will not be held responsible for any claims or damages resulting from installation.
- Door Panel Adjustment: The door panels of Swinging and Sliding Operating Doors must be adjusted to ensure proper operation and performance. The width of the gaps on the left and right should be similar. The width of the gaps on the top and bottom should be similar. All the gaps should be uniformly straight from one end to another. If you have questions, please see Windsor's Care and Use Guide at www.windsorwindows.com/support/service-information.

CAUTION: Misaligned door panels will result in a misaligned seal which will adversely affect the performance of the door. As a result, the failure to maintain proper door adjustment will void Windsor's warranty.

- Always provide a copy of these instructions to the homeowner.
- These instructions are consistent with ASTM 2112 "Standard Practice for Installation of Exterior Windows, Doors and Skylights" into common wall constructions. For installation into air barrier sheathing systems such as ZIP System, refer to our supplemental installation instructions at www.windsorwindows.com. Contact your architect or construction professional for installation into other building designs or construction methods.
- Regional codes and environmental conditions may require installation that is different from these guidelines. It is your responsibility to ensure that local codes and ordinances are followed.

Warning

- ⚠ **Work Safe!** Always wear proper eye and hearing protection when installing or adjusting Windsor products.
- ⚠ **Use Power Tools Properly!** To avoid personal injury, always follow manufacturers' instructions for safe operation of power tools.

- ⚠ **Ladder Safety!** Working at elevated levels can be hazardous. Always use ladders and scaffolding properly. Consult manufacturers' guidelines for safe use of these types of equipment.
- ⚠ **Safety Glazing!** Windsor products do not contain safety glazing unless specifically ordered that way. Use caution – injury could result if glass is broken and fragmented. Building codes require safety glazing for doors installed in certain areas. Consult your local building code official for guidelines.

Important

- Windsor reserves the right to change the information contained in these guidelines without notice.
- Maintain a minimum of 1/4" between the door frame and any trim, siding or masonry.
- **WARNING:** Use of Windsor products in barrier systems that lack a suitable exterior like siding, masonry, stucco, or EIFS with an engineered drainage system, will void all Windsor warranties written or implied and Windsor Windows & Doors will not be held responsible for any claims or damages resulting from the lack of a suitable exterior. The lack of a suitable exterior as described herein prevents application of proper perimeter sealant of the windows or door frame as required by Windsor's Installation Guidelines. Exterior membranes, liquid applied and otherwise, DO NOT qualify as a suitable exterior.
- Steel fasteners will corrode when used with ACQ pressure treated lumber. Use corrosion-resistant fasteners (such as stainless steel) when installing doors in or around these types of materials.
- Door nailing flanges and drip caps (integral or applied) do not take the place of door flashing. All windows and doors must be properly flashed and sealed around the perimeter.

Handling and Storage

CAUTION: Prefinished Interiors: Windsor products with prefinished interiors must be protected from dents, scratches, scrapes or other blemishes. Windsor does not warrant against dents, scratches, scrapes or other damage to prefinished interiors after the Windsor products leave Windsor's possession.

After the Windsor products leave Windsor's possession, extreme care must be taken by those moving the doors, or those working on or around the doors, to protect prefinished interiors from dents, scratches, scrapes or other blemishes.

Follow these procedures for proper storage and handling of windows and doors:

- **Remove stretch wrap immediately so the individual units can be exposed to circulated air.**
- **Do not store units outside or in direct sunlight. Allow sufficient spacing between products for ventilation.**
- **Never store units in a closed truck or other similar enclosure where the units can get too hot.**
- **Never stack or lean units against each other in the sun.**
- **Always store units vertically. Do not store units flat or stack horizontally.**
- **Units must be stored in a clean, dry, well-ventilated and enclosed area.**
- **Units with unsupported nailing fins should have their corners blocked and protected to prevent damage to the nailing fin.**
- **Always carry door units upright. Do not carry flat! Doing so could result in damage to the unit.**

Failure to follow these procedures will void our product warranty.

LEAD PAINT AND EXISTING DOOR DISPOSAL:

- A) Before any remodel or renovation, make sure to identify any potential lead paint issues and take necessary steps to reduce the risk of lead contamination.
- B) The U.S. Environmental Protection Agency (EPA) has issued a "Lead Renovation, Repair and Painting Rule (RRP)" for remodelers of older homes and buildings. This rule requires training and certification in lead-safe work practices for firms performing renovation, repair or painting on homes and child-occupied facilities built prior to 1978.

- C) For more information regarding procedures for dealing with lead paint, please visit EPA's website at www.epa.gov/lead.
- D) When removing existing doors, make sure to wear appropriate personal protective equipment. Extra precautions should be taken to protect others and property within the vicinity and below the removal door and surrounding components.
- E) Consult with local waste authorities on the proper recycling or disposal of old door components.

Tools Needed

- Safety Glasses



- Utility Knife



- Hammer (or nail gun)



- Caulk Gun



- Level



- Ladder / Scaffolding



- Square



- Tape Measure



- Stapler



Materials Needed

- Backer Rod
 - 1/4"-1/2" diameter closed cell foam
- Insulation
 - Minimally expanding low pressure polyurethane window and door foam
- Shims
 - Made of cedar or synthetic material
- Casing Nails
 - 16d Galvanized
- Silicone Sealant
 - 100% Silicone
- Flashing
 - Self-adhesive flexible flashing that complies with AAMA-711
- Rigid Metal Flashing and Fasteners
 - Applied to head brickmould

ATTENTION! ARBITRATION AGREEMENT; JURY TRIAL WAIVER; CLASS ACTION WAIVER. By purchasing, installing or using this product, you agree to arbitrate any dispute you may have with Windsor relating to your Windsor products, and to waive your rights to a jury trial and to participate in class-action or class-arbitration proceedings, relating to any such disputes. For more details, and to learn how **YOU CAN OPT OUT OF THIS ARBITRATION AGREEMENT AND THESE WAIVERS**, please go to www.windsorwindows.com/support/Dispute-Resolution.

Step 1: Inspect Unit

Before Installation:

- Remove all shipping packaging material (blocks, pads, protectors, stretch wrap).
- Inspect unit for any damage or defects.
- Verify that the door unit is the correct size and configuration.
- Contact your nearest Windsor distributor if there are any problems.

Step 2: Prepare Rough Opening

- Measure and verify the size of the rough opening. The rough opening should be $\frac{3}{4}$ " larger in width and $\frac{1}{2}$ " larger in height than the frame size.
- Verify the rough opening is flat, plumb, level and square. (Fig. 1)
- Take diagonal measurements to check for square. (Fig. 1)
- Make sure the bottom sill area of the rough opening is flat and level. Correct rough opening if sloped toward the interior, out of level or humped. (Fig. 1)
- Make an "I-Cut" in the weather-resistant barrier (WRB). Begin with a horizontal cut along the bottom and the top of the rough opening. Then make a vertical cut in the center from top to bottom. (Fig. 2)

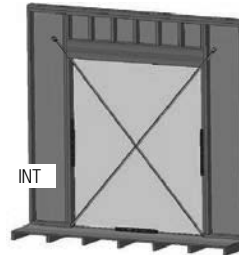

FIG. 1

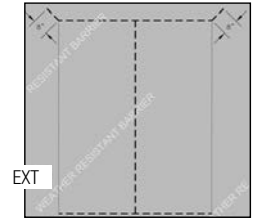

FIG. 2

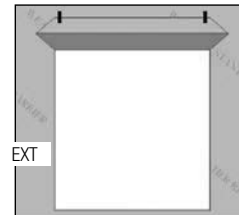

FIG. 3

- From the exterior, cut the top of the WRB as shown to form a flap. (Fig. 3)
- Temporarily tape this top flap up. (Fig. 3)
- Fold side flaps into rough opening and secure to inside wall. Cut off excess flap if desired.

Step 3: Flashing the Rough Opening

A) IMPORTANT:

- a. Use flashing that is 6" minimum in width.
 - b. Flashing must meet AAMA-711 performance requirements.
 - c. Adhesive or mechanically-fastened flashing may be used.
- B) Measure the width of the rough opening. Cut a length of flashing that is 12" wider than the rough opening. This will allow you to run the flashing 6" up each side.
- C) Cut 1-1/2" slits at each end of the flashing as shown below. (Fig. 4)



FIG. 4

- D) Apply sill flashing to the rough opening as shown below. (Fig. 5)
- E) Flashing tape must cover the entire sill. If needed, apply an additional flashing piece over the first one (start from the exterior and work toward the interior). Maintain a minimum 1" overlap. (Fig. 6)
- F) Cut and apply flashing to both sides and the top of the rough opening. Overlap the top flashing over the side flashing. The flashing should run at least 6" past each side of the rough opening. (Fig. 7)

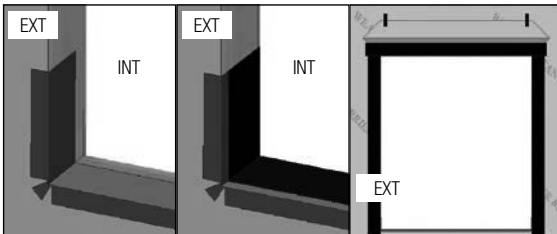

FIG. 5

FIG. 6

FIG. 7

Step 4: Door Installation

For Impact-rated products and/or any products installed in the Florida or Texas TDI regions, supplemental anchoring methods may be required. Refer to supplemental instructions attached to unit or www.windsorwindows.com for further information.

- A) Remove all packaging material (blocks, pads, protectors, stretch wrap).
- B) Inspect and verify the following:
- a. The door unit is the correct size and configuration.
 - b. The unit is free from any damage or defects.
- C) Contact your nearest Windsor distributor if there are any problems with Step B above.
- D) Apply sealant on the backside of the head and side brickmould. Apply a 1/4" continuous bead of silicone along the entire length a 1/4" from the outside edge of the brickmould. (Fig. 8)

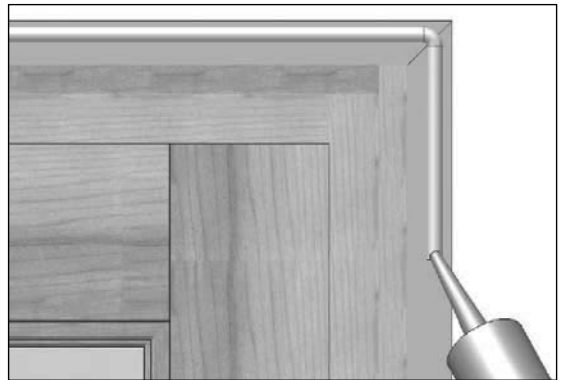

FIG. 8

- E) Apply sealant to sill rough opening (Skip Step E for the handicap sill option):
- Apply three 1/4" continuous beads of silicone across the entire width of the rough opening. Note that the locations are different for each door type. Figure 9 shows the silicone location for a 4-9/16" and 6-9/16" in-swing door. The bead location will be different for other jamb sizes. (Fig. 9 & 10)
 - Apply a 1/4" continuous bead of silicone 1/2" from each side of the rough opening. The bead will run the entire depth of the jamb starting at the face of the wall. (Fig. 11)

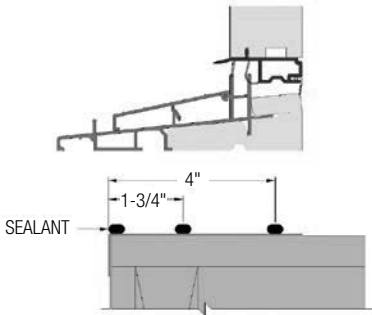

FIG. 9: 4-9/16" & 6-9/16" IN-SWING PATIO DOOR SILL

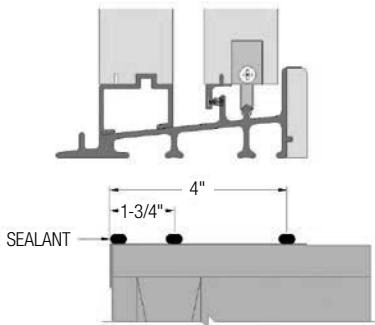

FIG. 10: SLIDING PATIO DOOR SILL

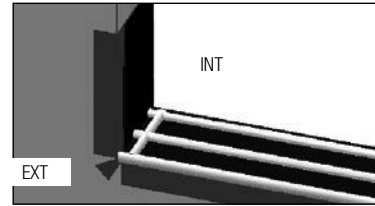

FIG. 11

- Set the door into the rough opening. Center the unit in the opening, making sure there are equal gaps on both sides of the door.
- Temporarily tack the door in place using 16d nails through the brickmould. Place the nails within 4" of each corner. Do not drive the nails in fully.
- Start with a shim at each corner no more than 1" from the jamb corner. Add additional shims spaced evenly from the center of the unit. Make sure shims are spaced no more than 16" apart. Use flat shims or pairs of triangle shims to ensure the jamb does not twist. (Fig. 12)
- Additional shims are required at each lock point, head shootbolt and hinge location for all operating doors. (Fig. 12)
- Nail all four corners in place through the brickmould.
- Finish nailing the door into place through the brickmould. Space the nails 8"-10" apart.

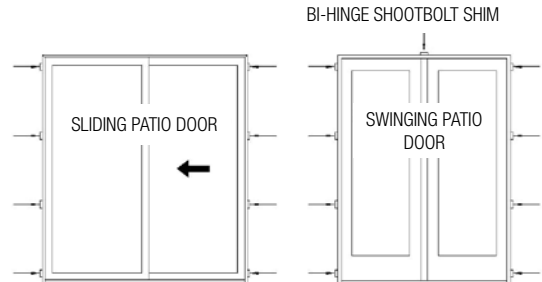

FIG. 12

Swinging Patio Doors

- L) Apply the supplied #10 x 2-1/4" screws through each hinge, securing the hinges and frame to the rough opening. Additional shims are required behind each hinge. (Fig. 13)

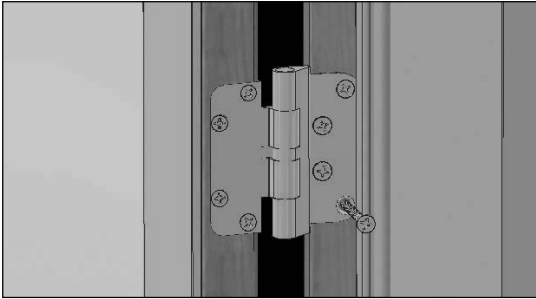

FIG. 13

Installation Fasteners			
Substrate	Fastener	Type of Steel	Minimum Embedment into Framing
Wood	16d Finish Nail	Galvanized, Stainless Steel, Zinc Plated	2"
Wood	#6 Wood Screw	Galvanized, Stainless Steel, Zinc Plated	2"
Steel	#8 Self Tap/Drill Screw		Fully Threaded

Step 5: Verify Operation

- A) Verify the operation of the door is correct. By doing so you will verify that the door either swings or slides without binding on another member of the door and by remaining motionless throughout the operation when left in a static position.

- B) If the operation of the door is not correct, first verify that the rough opening is flat, plumb, level and square. Second, verify that the door is shimmed and fastened properly as stated in these instructions. Third, verify that the rollers and hinges are adjusted to the optimal position. Refer to Step 9: Completing the Installation and review the Care and Use Guide at www.windsorwindows.com for further information on hardware adjustments. Also, a supplemental hinge adjustment sheet is included with the hinge and strike plate screwpack, which can be used as a quick reference guide.

Step 6: Completing the Sill

- A) Attach a sill support block beneath the sill. Apply a bead of sealant at the nose of the sill and support block. Continue the bead of sealant around the bottom edge of the brickmould to the rough opening. (Fig. 14 & 15)

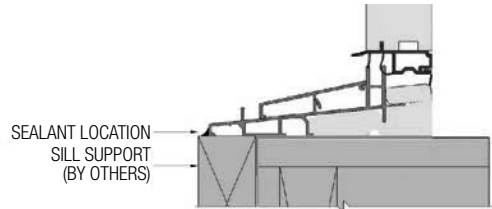

FIG. 14: STANDARD DOOR SILL

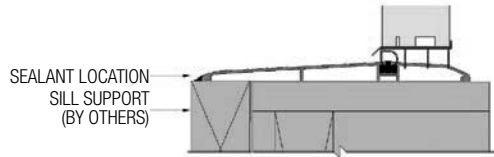

FIG. 15: HANDICAP DOOR SILL

- B) For in-swing patio doors: Apply silicone to seal each end of the sill cavity that protrudes out from the brickmould, including handicap sill. (Fig. 16)

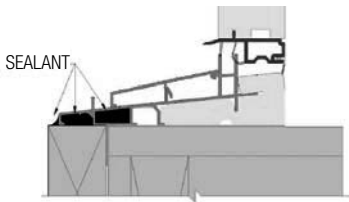

FIG. 16: IN-SWING DOOR SILL



Note: Rigid flashing must run at least 1/8" past the brickmould.

FIG. 18

Step 7: Complete Head Flashing

- A) Apply sealant: Apply a horizontal bead of sealant between the top edge of the rigid metal flashing and flashing and the top of the brickmould. (Fig. 17)
- B) Apply the rigid metal flashing. The flashing should extend approximately 1/8" past the edge of the brickmould on each side. Nail the flashing to the rough opening using at least a 1" roofing nail every 8"-10" approximately 1/2" below the top edge of the rigid flashing. Ensure that the nail is compatible with the rigid flashing material to prevent corrosion. (Fig. 17 & 18)
- C) Overlap the WRB over the rigid metal flashing. Trim the excess WRB at the rigid flashing bend that is directly below the rigid flashing nail. (Fig. 17 & 18)
- D) Tape the cut seams of the WRB. (Fig. 18)

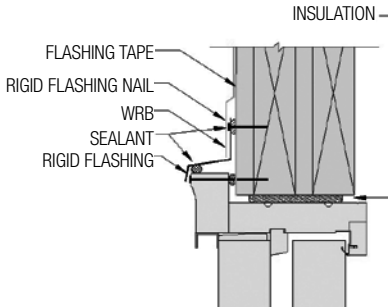

FIG. 17: HEAD JAMB

Step 8: Seal the Exterior

- A) After siding or wall exterior is complete, apply backer rod and sealant between the door frame and siding material on both sides. (Fig. 19)
- B) **WARNING:** Maintain a minimum of 1/4" between the door frame and any trim, siding or masonry. Failure to do so will forfeit all warranties (written or implied). Windsor Windows & Doors will not be held responsible for any claims or damages resulting from failure to follow these instructions.

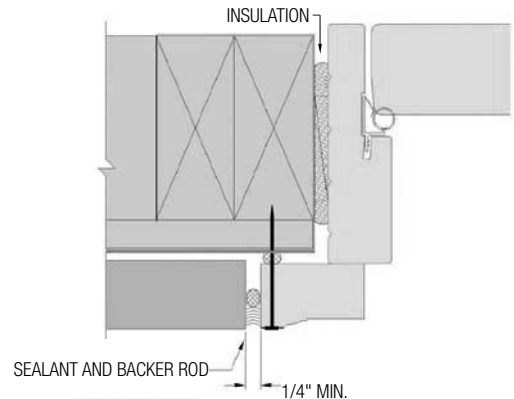

FIG. 19: SIDE JAMB

Step 9: Completing the Installation

- A) Remove all labels or shipping materials.
- B) Various hardware adjustments may be required after installation. See the Care and Use Guide located at www.windsorwindows.com for further details.
- C) Sliding patio doors: After the operating panel and keeper are adjusted to the optimal position, apply the supplied #10 x 1-1/4" screws through the top and bottom holes of the keeper. Pre-drill the holes using a 1/8" bit prior to assembly. (Fig. 20)
- D) Insulate between the door frame and the rough opening using minimally expanding window and door spray foam insulation. Use caution to not overfill the gap, causing the jambs to bow. It is not recommended to apply trim to the unit until the foam has cured to allow the excess to escape. (Fig. 17 & 19)
- E) Adjust door panels using the Swinging Door Panel Adjustment Instructions or the Sliding Door Panel Adjustment Instructions shown on the following pages.
- F) Operate door unit to ensure proper operation. The panel will not operate correctly if the door is out of square, over-shimmed or over-insulated.
- G) Properly finish all interior wood components within 60 days of installation. See the Care and Use Guide at www.windsorwindows.com for further details on finishing Legend HBR doors.
- H) **IMPORTANT:** Do not stain or paint any hardware or vinyl components.
- I) Apply the handle set as appropriate per manufacturers' recommendations. Complete final adjustments as necessary.

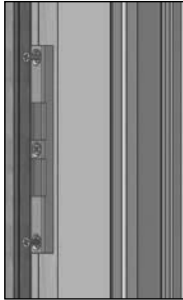

FIG. 20

- J) Sliding and swinging doors are to remain closed and locked during construction to prevent site conditions from damaging and/or warping panels and frames. Allow 10-12 weeks from project completion for building temperature and humidity levels to stabilize and door panels to acclimate.

Swinging Door Panel Adjustment Introduction

There are two types of Adjustable Hinges on each door panel:

1. Set Hinge: One or two per panel. the set hinge provides +/- 0.12" vertical adjustment.
2. Guide Hinge: Two or three per panel. The guide hinges provide +/- 0.12" horizontal adjustment. Look for the visible adjusting screw on the door sash leaf. This identifies the hinge as a guide hinge.
3. Hinge designs may vary, but adjustment remains the same.

Required Tools

1. A 3/16" hex wrench is required.
2. A small flat head screwdriver is required.
3. A plastic putty knife is recommended.

Vertical Adjustment for Doors with One Set Hinge

With the door closed or open:

1. Remove the press-fit Fial Cap from the bottom of the Set Hinge to expose the adjustment screw. Use the small flat head screwdriver for Set Hinges featuring a plastic Fial Cap. A plastic putty knife is recommended for Set Hinges featuring a brass Fial Cap.
2. Insert the 13/16" hex wrench into the bottom of the Set Hinge. Tighten the screw to raise the panel and loosen to lower the panel.
3. Reinstall the Fial Cap removed in Step 1.

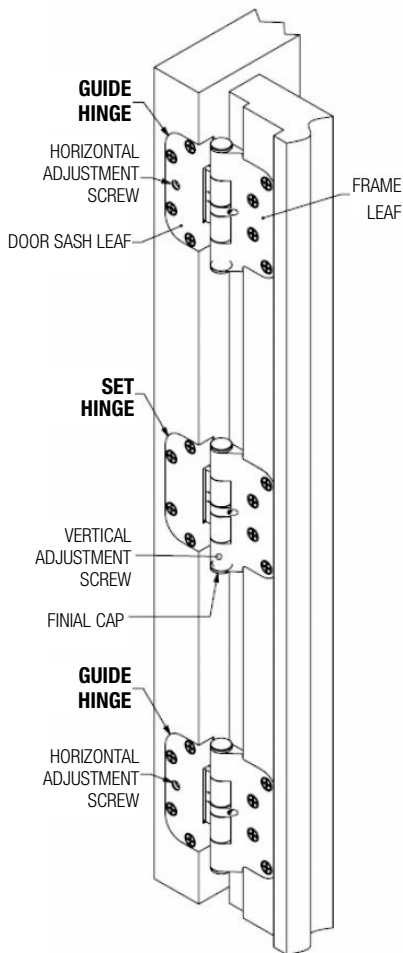

Vertical Adjustment for Doors with Two Set Hinges

With the door closed or open:

1. Remove the press-fit Finial Cap from the bottom of the Set Hinge to expose the adjustment screw. Use the small screwdriver for Set Hinges featuring a plastic Finial Cap. A plastic putty knife is recommended for Set Hinges featuring a brass Finial Cap.
2. To raise the panel, insert the hex wrench into the topmost Set Hinge and tighten the adjustment screw to achieve the desired adjustment. Insert the hex wrench into the other Set Hinge and tighten the adjustment screw 1/8 turn past the onset of resistance to distribute the panel weight evenly between both Set Hinges.

Sliding Door Panel Adjustment

To ensure your door is performing properly, the active panel should be parallel with the side jamb. Locate the panel edge about 1/16" from the edge of the side parting stop. If the gap is not consistent from top to bottom, the panel requires adjustment. At the bottom edges of the active panel are roller adjustment screws. Using a screwdriver, turn the screws to adjust each side of the panel up or down until the panel is parallel with the side jamb.



www.windsorwindows.com