

# Pinnacle Series

## ACCESSORIES

### ALUMINUM EXPANDERS AND MULLIONS

THESE ALUMINUM ACCESSORIES CAN BE APPLIED TO WINDSOR CLAD CASEMENT, AWNING, DOUBLE HUNG, GLIDE-BY, SLIDING PATIO DOOR AND DIRECT SET WINDOWS.



P.N.: 2374065  
LINEAL LENGTHS: 14'



P.N.: 420044  
LINEAL LENGTHS: 14'

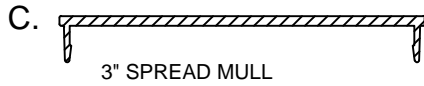

P.N.: 420052  
LINEAL LENGTHS: 14'

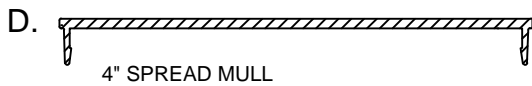

P.N.: 420060  
LINEAL LENGTHS: 14'

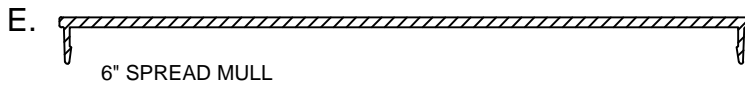

P.N.: 420076  
LINEAL LENGTHS: 14'



STANDARD CLAD MULLION

P.N.: 480005  
LINEAL LENGTHS: 14'

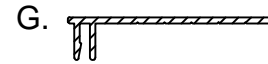

SMALL FRAME EXPANDER (1-7/8")

P.N.: 480027  
LINEAL LENGTHS: 14'

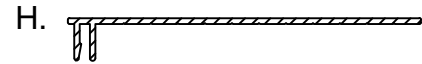

LARGE FRAME EXPANDER (3-1/4")

P.N.: 480019  
LINEAL LENGTHS: 14'



SPREAD MULL END CAP

P.N.: 420017

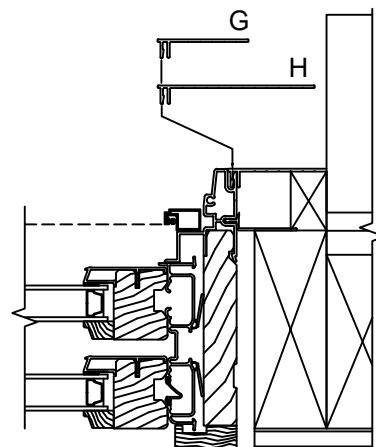
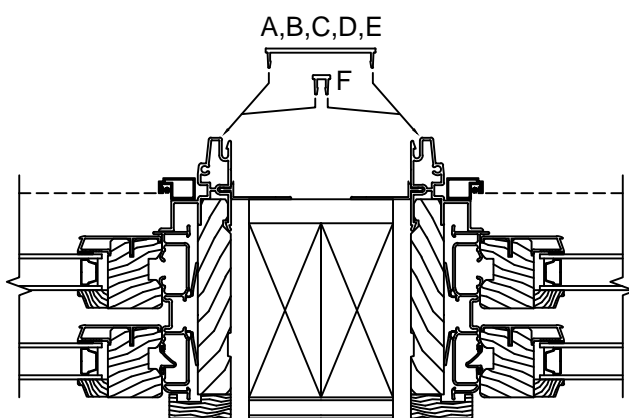

# Pinnacle Series

## ACCESSORIES

### LINEAL PARTS

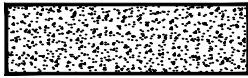

P.N. 2390000  
LINEAL - 16'

3 1/2" FLAT CASING



P.N. 2380448  
LINEAL - 14'

4 1/2" BACKBAND CASING



P.N. 2390001  
LINEAL - 16'

5 1/2" FLAT CASING



P.N. 2380065  
LINEAL - 14'

WILLIAMSBURG BRICKMOULD



P.N. 2390003  
LINEAL - 14'

BRICKMOULD WM-180

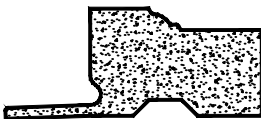

P.N. 2380059  
LINEAL - 12'

180 FLANGED BRICKMOULD



P.N. 2380438  
LINEAL - 14'

PRIMED CASEMENT SUBSILL

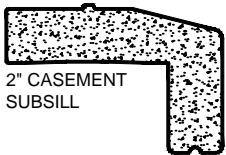

P.N. 2380022  
LINEAL - 14'

2" CASEMENT  
SUBSILL



WOOD



PVC



P.N. 291018  
LINEAL - 10'

CASEMENT 7/16 INCH JAMB EXTENSION



P.N. 291065  
LINEAL - 10'

CASEMENT 7/16 INCH FULL WIDTH  
JAMB EXTENSION



P.N. 140122  
LINEAL - 10'

CASEMENT 11/16 INCH  
EXTENSION JAMB



P.N. 291020  
LINEAL - 10'

CASEMENT 1 1/8 INCH  
JAMB EXTENSION



P.N. 140103  
LINEAL - 10'

DOUBLE HUNG / GLIDE BY 2 INCH  
JAMB EXTENSION



P.N. 291022  
LINEAL - 10'

CASEMENT 2 7/16 INCH  
JAMB EXTENSION



P.N. 140123  
LINEAL - 16'

CASEMENT 2 11/16 INCH  
JAMB EXTENSION



P.N. 291024  
LINEAL - 10'

CASEMENT 3 1/8 INCH  
JAMB EXTENSION



P.N. 2381698  
LINEAL - 14'

2" BULL SILL NOSE



P.N. 2379998  
LINEAL - 12'

BELLY SILL NOSE



P.N. 2380019  
LINEAL - 12'

DOUBLE HUNG SILL NOSE



P.N. 2390012  
LINEAL - 14'

HORIZONTAL OUTSIDE  
MULL COVER



P.N. 2390013  
LINEAL - 14'

VERTICAL OUTSIDE  
MULL COVER



P.N. 2390010  
LINEAL - 12'

DOUBLE HUNG VERTICAL  
OUTSIDE MULL COVER

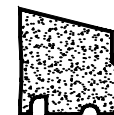

P.N. 2380021  
LINEAL - 12'

HALF ROUND / ELLIPSE  
SILL NOSE

# Pinnacle Series

## ACCESSORIES

### LINEAL WOOD PARTS



P.N. 292000

DOUBLE HUNG 30° BAY INSIDE MULL

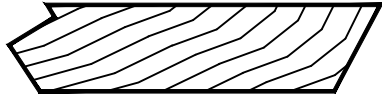

P.N. 292012

DOUBLE HUNG 30° BAY 6 9/16" JAMB EXTENSION

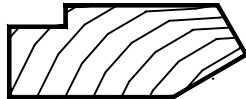

P.N. 292010

DOUBLE HUNG 30° BAY 4 9/16" JAMB EXTENSION

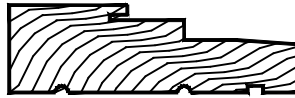

P.N. 291032

PRIMED CASEMENT / DIRECT SET JAMB

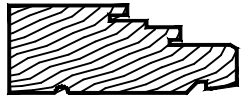

P.N. 2370043  
LINEAL - 14'

CLAD CASEMENT / DIRECT SET JAMB



P.N. 291000  
LINEAL - 10'

CASEMENT INSIDE MULL COVER

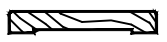

P.N. 292130  
LINEAL - 11'

DOUBLE HUNG INSIDE MULL COVER



P.N. 292115  
LINEAL - 16'

CASEMENT HALF ROUND HORIZONTAL  
INTERIOR MULL



P.N. 291010  
LINEAL - 10'

CASEMENT 45° BAY INSIDE MULL



P.N. 291008  
LINEAL - 10'

CASEMENT 30° BAY INSIDE MULL



P.N. 291006  
LINEAL - 10'

CASEMENT 12° INSIDE MULL

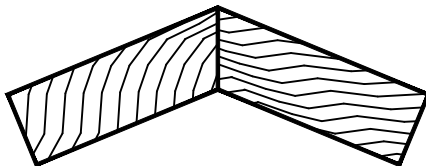

P.N. 291016  
LINEAL - 10'

PRIMED CASEMENT 45° BAY OUTSIDE MULL

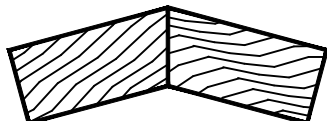

P.N. 291014  
LINEAL - 14'

PRIMED CASEMENT 30° BAY OUTSIDE MULL



P.N. 291012  
LINEAL - 14'

PRIMED CASEMENT 12° BOW OUTSIDE MULL



P.N. 292002

DOUBLE HUNG 45° BAY INSIDE MULL



P.N. 292016

DOUBLE HUNG 45° BAY 6 9/16" JAMB EXTENSION

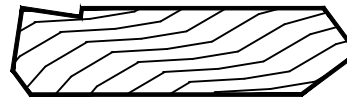

P.N. 292014

DOUBLE HUNG 45° BAY 4 9/16" JAMB EXTENSION



P.N. 250123  
LINEAL - 10'

PRIMED & CLAD INSIDE STOP



P.N. 290080  
LINEAL - 10'

DIRECT SET INSIDE STOP



P.N. 291040  
LINEAL - 14'

PRIMED DIRECT SET OUTSIDE STOP



P.N. 291042  
LINEAL - 7'

CASEMENT 30° BAY SIDE JAMB EXTENSION



P.N. 291030  
LINEAL - 7'

CASEMENT 45° BAY SIDE JAMB EXTENSION

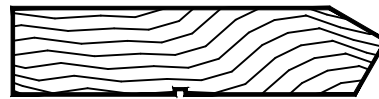

P.N. 291026  
LINEAL - 7'

CASEMENT 4 WIDE BOW EXTENSION



P.N. 291028  
LINEAL - 7'

CASEMENT 5 WIDE BOW EXTENSION



P.N. 237073  
LINEAL - 11'

PRIMED & CLAD DOUBLE HUNG SILL INSIDE STOP

# Pinnacle Series

## ACCESSORIES

LINEAL METAL & VINYL PARTS

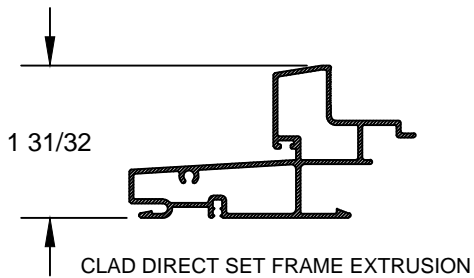

CLAD DIRECT SET FRAME EXTRUSION

P.N.: 2370456  
LINEAL LENGTHS - 14'

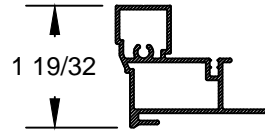

CLAD BRICKMOULD EXTRUSION

6063-T5 P.N.: 481025  
6063-T52 P.N.: 482166  
LINEAL LENGTHS: 14'

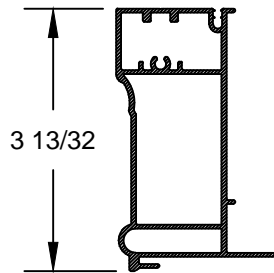

WILLIAMSBURG CASING

6063-T5 P.N.: 460033  
6063-T52 P.N.: 460004  
LINEAL LENGTHS: 14'

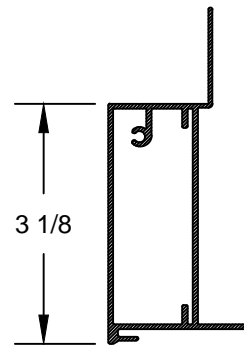

3 1/2" CLAD FLAT CASING

P.N. 460040  
LINEAL LENGTH - 17'  
MILL FINISH

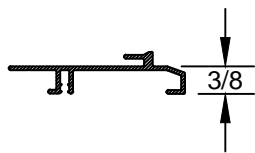

3/8" CLAD BRICKMOULD  
SUBSILL EXTRUSION

P.N.: 482170  
LINEAL LENGTHS: 14'

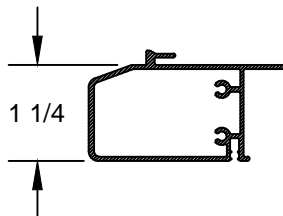

1 1/4" CLAD SUBSILL EXTRUSION

P.N. 460042  
LINEAL LENGTH - 13'  
MILL FINISH

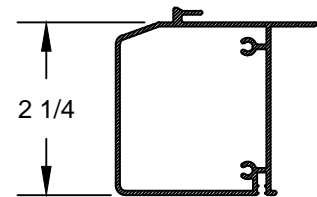

2 1/4" CLAD SUBSILL EXTRUSION

P.N. 460043  
LINEAL LENGTH - 13'  
MILL FINISH

# Pinnacle Series

## ACCESSORIES

### LINEAL METAL & VINYL PARTS

---

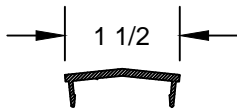

CLAD 12° OUTSIDE MULL  
P.N.: 481001  
LINEAL LENGTHS: 14'



CLAD BRICKMOULD FILLER STRIP  
P.N.: 538031  
LINEAL LENGTH: 12'

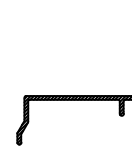

RIGID DRIP CAP  
P.N.: 483037  
LENGTH: 14'

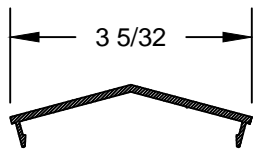

30° OUTSIDE MULL  
P.N.: 480021  
LINEAL LENGTHS: 14'

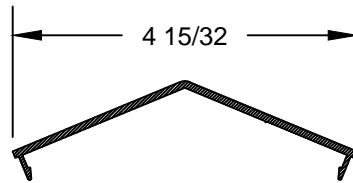

45° OUTSIDE MULL  
P.N.: 481018  
LINEAL LENGTHS: 14'

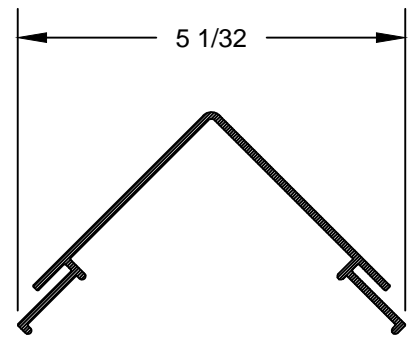

90° OUTSIDE MULL  
P.N.: 584023  
LINEAL LENGTHS: 14'

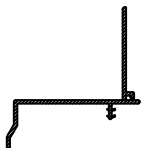

VINYL DRIP CAP (HINGED)  
P.N.: 471005 LINEAL  
LENGTH: 14'



NAIL FIN (HINGED)  
P.N.: 460015 LINEAL  
LENGTH: 14'



NAIL FIN (NON HINGED)  
P.N.: 478002 LINEAL  
LENGTH: 14'



RIGID ALUMINUM NAIL FIN  
P.N.: 460025 LINEAL  
LENGTH: 14'